

# HAITIMA

## Instruction Manual

### Flanged End Gate Valve

2054

HIM-081 Version: B



Office : 8F, No.201, Tiding Blvd. Sec.2, Taipei, 114, Taiwan Web-site: [www.haitima.com.tw](http://www.haitima.com.tw)

Fax: +886-2-2658-3830 , 2658-2266 Tel:+886-2-2658-5800 E-mail: [haitima@seed.net.tw](mailto:haitima@seed.net.tw)

		<b>Flanged End Gate Valve 2054</b>	<b>Version</b>	<b>B</b>
			Date	Nov.26.2012
Document No.	HIM-081			

# CONTENTS

1. Introduction and Safety Information .....	1
1.1 Introduction .....	1
1.2 Safety Information .....	1
2. General Precautions.....	2
2.1 Storage .....	2
2.2 Preparation .....	2
3. Installation and Operation .....	3
3.1 Installation .....	3
3.2 Operation .....	3
4. Maintenance and Repair.....	4
4.1 Inspection and Maintenance .....	4
4.2 Trouble-Shooting .....	5
4.3 Stem Packing Replacement.....	6
4.4 Disassembly.....	7
4.4 Reassembly .....	7
5. Quality Assurance and Service .....	9
5.1 Quality Assurance .....	9
5.2 Service.....	9
6. Technical Parameters.....	9
6.1 Specification List .....	9
6.2 Bonnet Bolt Torque .....	10
6.3 Pressure-Temperature Ratings .....	10
7. Gate Valve structure .....	11

		<b>Flanged End Gate Valve 2054</b>	<b>Version</b>	<b>B</b>
			Date	Nov.26.2012
Document No.	HIM-081		Page	1

## 1. INTRODUCTION AND SAFETY INFORMATION

### 1.1 INTRODUCTION

This manual has been prepared to serve as a guide to insure continuous satisfactory service and assist in restoring a valve to proper working condition.

It covers CLASS 150/300, PN16/40 flanged ends, bolt bonnet, outside screw and yoke, stainless steel gate valves. The installation, storage, operation, disassembly / reassembly inspection and repair, service problems, maintenance and preventive maintenance covering these gate valves are also included in this manual.

Prior to performing any work on these gate valves, it would be useful to have a general understanding of their construction.

### 1.2 SAFETY INFORMATION

The following general safety notices supplement the specific warnings and cautions appearing elsewhere in this manual. They are recommended precautions that must be understood and applied during operation and maintenance of the equipment covered herein.

- a. Always wear eye shields, gloves and overalls. Wear protective footwear and headgear.
- b. To avoid injury, never attempt disassembly while there are pressures either upstream, or downstream. Even when replacing packing rings, caution is necessary to avoid possible injury.
- c. Do not attempt to disassemble a gate valve while there is pressure in the line. Make sure both upstream and downstream pressures are removed. Disassemble with caution in the event all pressures have not been relieved.
- d. Prior to replacing packing rings remove all pressure from the valve.
- e. To prevent valve distortion, inefficient operation, or early maintenance problems, support piping on each side of the gate valve.
- f. Do not touch surface of gate valve on high temperature.
- g. Gate valves are not to be used with unstable fluids.

		<b>Flanged End Gate Valve 2054</b>	<b>Version</b>	<b>B</b>
			Date	Nov.26.2012
Document No.	HIM-081		Page	2

## 2. GENERAL PRECAUTIONS

### 2.1 STORAGE

#### 2.1.1 Temporary Storage

If the gate valve is to be stored before installation, the following should be observed.

- a. Keep the gate valve wrapped and protected as shipped from the manufacturer.
- b. Do not remove the plastic bag or protective end covering until the gate valve is ready for installation. This will reduce the possibility of foreign material damaging internal gate valve components.
- c. Gate valve stored outdoors should be positioned such that water dose not accumulate in the valve body.

#### 2.1.2 Long Term Storage

If the gate valves are to be stored more than of one year, they should be prepared in the following manner.

- a. Store the gate valve in a dry area or protect the cavity by applying a preservative coating.
- b. Do not remove the protective end covering. (If any)
- c. Gate valve which will remain in storage for an excessive period of time should have a preservative applied to the external surface.
- d. Do not store the valves outdoors.

### 2.2 PREPARATION

- a. Remove the end protection. (If any)
- b. Prior to shipment from the manufacturer, a preservative may have been applied to the inner body of the gate valve. This preservative maybe removed with a solvent.
- c. The inside of the gate valve should be inspected and blown out with compressed air. As far as possible adjacent piping must be clean and free from debris to prevent early foulness of the gate valve.
- d. To prevent gate valve distortion, inefficient operation or early maintenance problems, support piping on each side of the gate valve.
- e. Make sure the valve is positioned such that there is sufficient space so that the hand wheel is easily and safely reached and there is enough clearance for the stem when the valve is open.
- f. Gate valves can be installed in any position without regard for the direction of the flow, unless marked in the flow direction.
- g. Gate valves are not designed for throttling and should be kept in the fully open or closed position. Should the valve be used in a partially open or closed position, the bottom of the wedge and the seat may become eroded in a very short time. This may also cause a chatter noise in the line.

		<b>Flanged End Gate Valve 2054</b>	<b>Version</b>	<b>B</b>
			Date	Nov.26.2012
Document No.	HIM-081		Page	3

### 3. INSTALLATION AND OPERATION

#### 3.1 INSTALLATION

##### Flange Ends

Bolting and gasket material should be compatible with the valve's body material and pressure. Care should be taken that flanges are strait and parallel. Bolts should be evenly tightened in a star pattern. This will ensure a uniform gasket loading.

#### 3.2 OPERATION

HAITIMA valves provide tight shut off when used under normal conditions and in accordance with pressure/temperature chart. If these gate valves are used in partially open (throttled) position seat life may be reduced. This may also cause a chatter noise in the line. Any media which might solidify, crystallize or polymerize should not be allowed to stand in the gate valve cavities unless regular maintenance is provided.

		<b>Flanged End Gate Valve 2054</b>	<b>Version</b>	<b>B</b>
			Date	Nov.26.2012
Document No.	HIM-081		Page	4

## 4. MAINTENANCE AND REPAIR

### 4.1 INSPECTION AND MAINTENANCE

A periodic inspection and maintenance schedule should be established for each gate valve. The time frames given for the implementation of these schedules are to be used as a guide only in establishing routine inspection and maintenance schedules. Exact time periods for performing these procedures cannot be provided due to the unknown nature of the service conditions each valve is in.

#### 4.1.1 Periodic Inspection

A periodic inspection should be performed on each unit. The time frame should be adjusted depending on usage and service conditions. An infrequently used unit may have more time between inspections than a gate valve in constant service.

A periodic inspection should include the following:

- a. Examine the valve stem for cleanliness and lubrication. The stem threads should be coated with a clean grease lubricant.
- B. Some valves have a grease fitting in the bonnet or yoke. If it is dry, lubricate with a hand grease gun.
- c. Open and close the valve. The actions should be smooth without any binding of the stem through full travel.
- d. If gate valve is in service and under pressure:
  - (1) Examine the body and bonnet for leakage through the gasket. If leakage is found, tighten the bonnet nuts evenly in a star pattern until the leakage stops. Do not exceed the maximum torque values. If the leakage persists, see section 4.2 "Troubleshooting".
  - (2) Check the stem packing for any leakage during the opening and closing action. If a leak is found tighten the gland nuts alternately with no more than a quarter turn on each nut until the leak stop. If the leakage persists, see section 4.2 "Troubleshooting".
  - (3) Inspect the exterior of the gate valve for cleanliness. Remove any dirt, grime or oil from the body and bonnet.
- c. After the system is depressurized:
 

Inspect the gate valve internally. Remove any dirt, grime or oil from the gate valve.

#### 4.1.2 Post Inspection

After completion of a periodic inspection, gate valves that are providing satisfactory service require no further disassembly or inspection. Should a gate valve be found which is not performing satisfactorily, see section 4.2 "Trouble-Shooting".

		<b>Flanged End Gate Valve 2054</b>	<b>Version</b>	<b>B</b>
			Date	Nov.26.2012
Document No.	HIM-081		Page	5

#### 4.1.3 Maintenance

Other than periodic inspection, no routine maintenance is required. Routine replacement of parts, such as gasket and packing is not usually performed until required. Once in service, it may become apparent that these and other parts require repair or replacement due to usage and service conditions. A maintenance schedule should be developed taking these conditions into consideration. Parts can be replaced during a routine overhaul.

## 4.2 TROUBLE-SHOOTING

The following chart will cover the various problems which are common to most gate valves.

The information provided will aid in isolating and correcting these problems.

PROBLEM	PROBABLE CAUSE	SOLUTION
Leakage through the stem packing	a. Gland nuts are loose. b. Gland is binding against the stem or packing chamber wall. c. Inadequate amount of packing rings. d. Packing is hard and dry. e. Packing was not properly cut and staggered. f. Stem is damaged.	a. Tighten gland bolts. b. Check to insure gland is centered and evenly tightened. c. Install additional packing rings see section 4.3. d. Replace with new packing see section 4.3. e. Replace with new packing see section 4.3. f. Repair or replace as required.
Problems in operating valve	g. Stem binding during travel. h. Stem packing is exerting excessive force on the stem. i. Stem is damaged. j. Internal components may be damaged.	g. Remove dirt and lubricate stem with Grease. h. Check torque on gland nuts. i. Examine stem through full open and close action. Repair or replace as required. j. Disassemble the valve. Inspect and repair as needed.
Bonnet Leakage	k. Bolt nuts are loose. l. Gasket is damaged. m. Body or bonnet faces are damaged.	k. Tighten to values. l. Disassemble and install a new gasket. m. Repair and install a new gasket.
Seat Leakage	n. Valve not properly seated. o. Internal components are damaged or worn.	n. Check to see if valve is tightly closed. o. Inspect internal components and repair as required.

Table 1 - Trouble-Shooting

		<b>Flanged End Gate Valve 2054</b>	<b>Version</b>	<b>B</b>
			Date	Nov.26.2012
Document No.	HIM-081		Page	6

### 4.3 STEM PACKING REPLACEMENT

#### **WARNING**

To prevent injury ensure that all pressure is removed from the valve both upstream and downstream before disassembly.

- a. Check original tightness of valve operation. Remove gland nuts. Lift. the gland up the stem clear of the packing chamber.
- b. Remove the existing or defective packing rings with a sharp tool or packing remover. Do not scratch or score the machined surfaces of the stem or packing chamber.
- c. Examine the machined surfaces of the stem and packing chamber. Remove any scratches, scoring or burrs with emery cloth or hand filing. Clean the stem with a solvent soaked rag.
- d. Install new packing. Install rings individually using a split ring spacer, compressing each ring by hand tightening + 1/4 turns on each cap nut.
- e. When packing chamber becomes filled with packing, reassemble gland and gland flange. Alternate tightening gland flange nuts 1/4 turn at a time until eye bolts begin to get tight. (If gland travels more than the height of one packing ring into the packing chamber, insert one more ring and repeat step F until chamber is filled.
- f. Compare valve operation to original tightness. If valve operation is considerably tighter than original operating tightness, back off 1/4 turn on each gland nut and recheck tightness.
- g. Several hours after a repacked valve has been returned to service, inspect the packing area to ensure full compression, tight bolting and no leakage. Should leakage occur, tighten gland nuts at 1/4 turn increments until leakage stops.



		<b>Flanged End Gate Valve 2054</b>	<b>Version</b>	<b>B</b>
			Date	Nov.26.2012
Document No.	HIM-081		Page	7

#### 4.4 DISASSEMBLY

##### **WARNING**

To prevent injury ensure that all pressure is removed from the valve both upstream and downstream before disassembly.

- a. Close the valve and then open, two full hand wheel turns. Match or mark flange with a metal tool or paint to clearly show the original position for reassembly.
- b. Caution should be taken when loosening body-bonnet bolting as pressure may still be present in bonnet.
- c. Once assured there is no more pressure in the line, remove the bonnet nuts and bolts. Lift the bonnet-stem wedge (or disc) assembly out of the body, taking care not to scratch the seating surface. As the assembly is drawn out of the body, match or mark the wedge so that it can be replaced in the same position.
- d. Remove the bonnet gasket from the valve body flange.
- e. Remove the wedge from the stem "T" head, carefully protecting the seating surface.
- f. Unfasten the hand wheel nut. Remove the hand wheel from the valve.
- g. To remove the valve stem, loosen the gland bolting and gland. Disengage the stem from the yoke sleeve by rotating it, counterclockwise and pulling from below until the stem is free of the packing chamber. Be careful not to score or scratch the stem machined surface or the threads.

#### 4.4 REASSEMBLY

- a. Thoroughly clean the valve interior and all components. Remove all scale, oil, grease or other foreign material. Wipe the seating surface of the wedge (or disc) and valve seat with a solvent soaked and all bolting.
- b. Install the stem carefully, sliding it through the packing and gland until the threads are engaged with the yoke sleeve. Slowly rotate the stem clockwise until it extends beyond the bonnet.
- c. Place hand wheel in position atop the valve, stem nut. Secure with hand wheel nut.
- d. Position a new gasket on the body flange aligned with the bolt holes. The gasket should not extend over the open body cavity. Do not reuse a gasket. The gasket may be coated with a light oil.
- e. Install the wedge to the "T" head of the stem connection.
- f. Lift the bonnet-stem-wedge assembly up and over the body. Check the location marks on the body, bonnet flange and wedge. Carefully lower the assembly until the body and bonnet flanges and the location marks meet. Again caution must be used to prevent scoring or scratching of the seating surfaces. Keeping the bonnet stationary, open the valve a few turns to ensure the wedge (or disc) is not touching the seat.

		<b>Flanged End Gate Valve 2054</b>	<b>Version</b>	<b>B</b>
			Date	Nov.26.2012
Document No.	HIM-081		Page	8

- g. Line up the body and bonnet holes. Make sure the gasket does not extend into any of the bolt holes. Install the bonnet bolting and tighten in a star pattern to evenly load the gasket to the torque values.
- h. Install new packing as per section 4.3.
- i. Align and center the gland in the packing chamber. Evenly tighten the gland nuts until snug, then alternate tightening with no more than a quarter turn on each.
- j. Open and close the valve using the hand wheel. The action should be smooth and regular through full stem travel.



		<b>Flanged End Gate Valve 2054</b>	<b>Version</b>	<b>B</b>
			Date	Nov.26.2012
Document No.	HIM-081		Page	9

## 5. QUALITY ASSURANCE AND SERVICE

### 5.1 QUALITY ASSURANCE

HAITIMA's warrants its products to be free from defects in material and workmanship for a period of eighteen (18) months from the date of shipment or twelve (12) months from the date of installation whichever comes first. This warranty is limited to the repair or replacement of the defective item providing that it was handled, installed, used and maintained in accordance with the manufacturer's recommendations and applicable standard industry practices. HAITIMA will not be liable for any additional direct or indirect costs beyond the repair or replacement of the defective item.

This warranty is in lieu of any other warranty expressed or implied.

### 5.2 SERVICE

Manufacturer may provide field installation and debugging where contractually specified.

Manufacturer will follow up the quality of the valve provided and offer service in accordance with customer requirements.

## 6. TECHNICAL PARAMETERS

### 6.1 SPECIFICATION LIST

Type	
Technical Parameters	2054
Nominal pipe size	DN15 ~ DN300, (1/2" ~ 12")
Nominal pressure	Class 150/300, PN16/40
Working temperature	-20°C ~ 200°C, (-4°F ~ 392°F)
Medium	Water, Steam, Oxygen, Vacuum, Chemical, Oil, Food Processing
Pressure test	API 598

Table 2 - Specification List

		<b>Flanged End Gate Valve 2054</b>	<b>Version</b>	<b>B</b>
			Date	Nov.26.2012
Document No.	HIM-081		Page	10

## 6.2 BONNET BOLT TORQUE

Class 150:

NPS	DN	Bonnet Bolt Torque		NPS	DN	Bonnet Bolt Torque	
		N-m	in-lb			N-m	in-lb
1/2"	15	15	133	3"	80	80	708
3/4"	20	40	354	4"	100	80	708
1"	25	40	354	5"	125	200	1770
1-1/4"	32	80	708	6"	150	200	1770
1-1/2"	40	80	708	8"	200	200	1770
2"	50	80	708	10"	250	360	3186
2-1/2"	65	80	708	12"	300	360	3186

Table 3 – Bonnet Nut Torque

## 6.3 PRESSURE-TEMPERATURE RATINGS

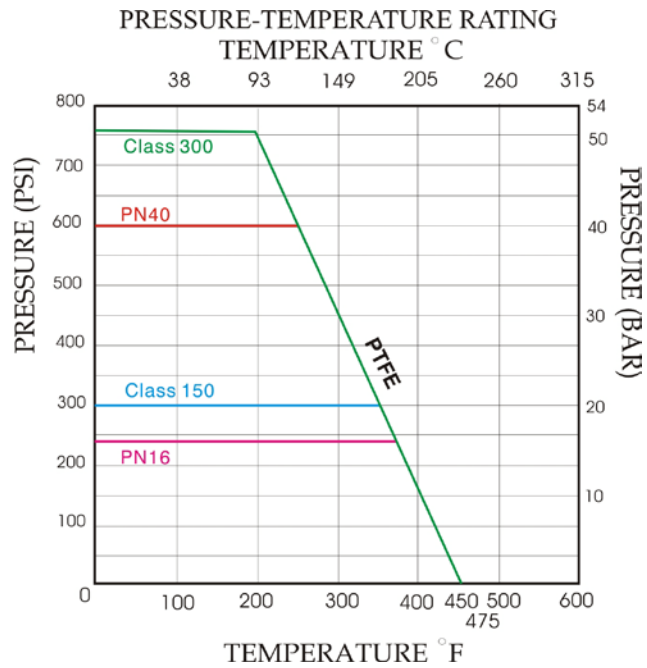
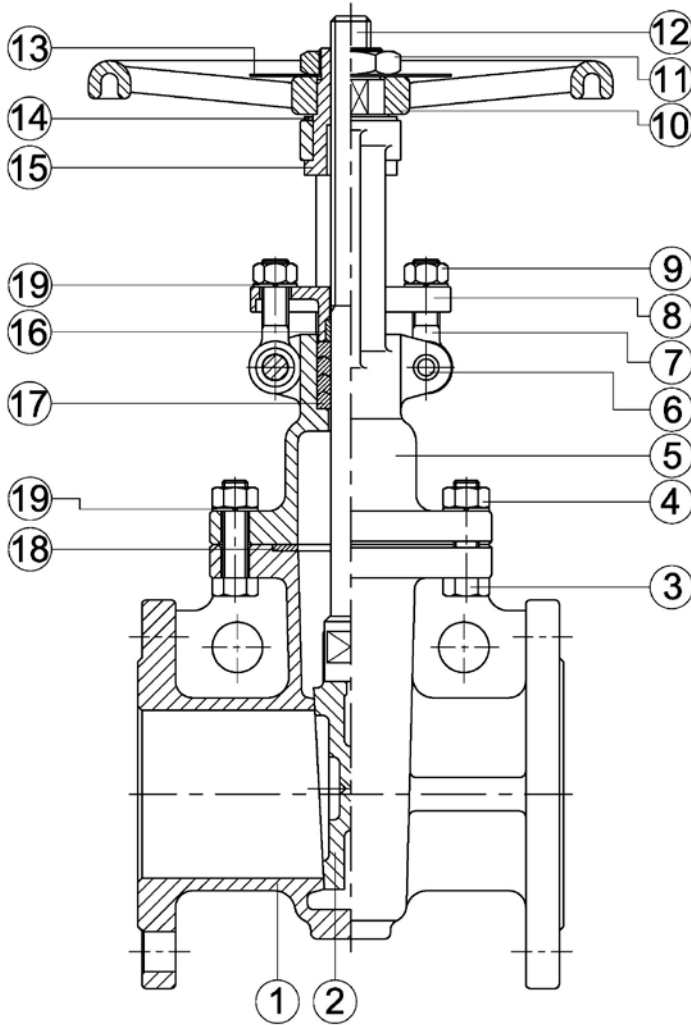

Table 4 - Pressure-Temperature Ratings

7. GATE VALVE STRUCTURE



ITEM	PARTS
1	BODY
2	DISC
3	BONNET BOLT
4	BONNET NUT
5	BONNET
6	HINGE PIN
7	EYE BOLT
8	GLAND
9	EYE NUT
10	HAND WHEEL
11	NUT
12	STEM
13	NAME PLATE
14	SPRING
15	YOKE SLEEVE
16	GLAND PACKING
17	PACKING
18	GASKET
19	SPRING WASHER